



CBI Astute Instruction Manual



Wi-Fi enabled
Scheduled energy management
Energy monitoring
Automation and IoT
Device automation sharing
CBI Home App and more



Installation

Astute Smart Controller (ASC)

1. This device must be installed by a qualified electrician.
2. Isolate supply before installing the ASC
3. Install the ASC on either mini rail or DIN rail (remove the escutcheon adaptor for DIN, see Figure 1)
4. Connect the ASC according to Figure 2 or 3. Observe markings for line and load terminals.
5. Download and install the CBI Home App from either the App Store or on Google Play

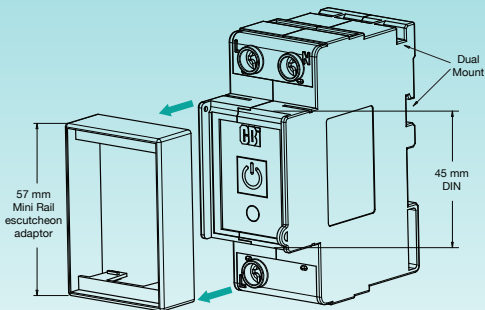

Figure 1: Escutcheon adaptor removal

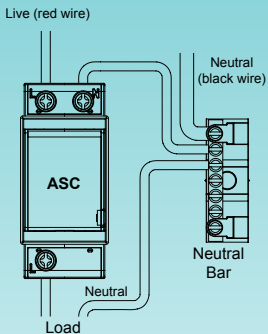

Figure 2: Distribution board wiring

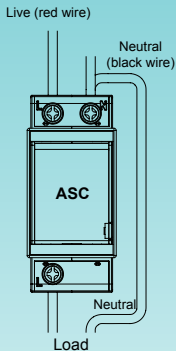
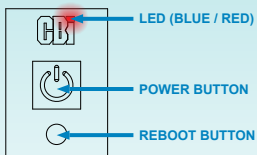

Figure 3: Stand alone wiring



Reboot Button - If needed, press and hold the reboot button for 1 second to reboot the ASC.

Installation

Astute Smart Isolator (ASI)

1. This device must be installed by a qualified electrician.
2. Isolate supply before installing the ASI
3. Install the ASI in the outlet box
4. Connect the ASI according to Figure 4. Observe markings for line and load terminals.
5. Download and install the CBI Home App from either the App Store or on Google Play

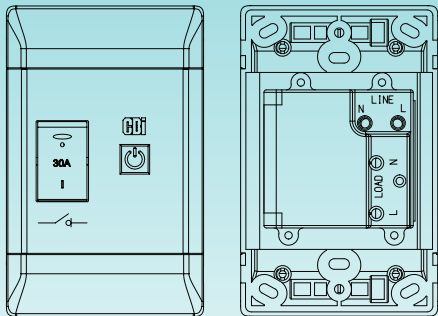
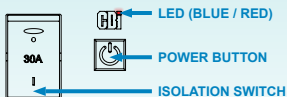

Figure 4: ASI installation



Isolation Switch - If needed, switch the isolation switch OFF, wait one second and switch it ON again to reboot the ASI.

CBI Astute Smart Controller (ASC) / Astute Smart Isolator (ASI)

- ONLY compatible with 2.4 GHz Wi-Fi with internet connection
- Free CBI Home App available to control these devices
- Manual ON / OFF switch (Power Button)
- Multiple ON / OFF programs

Specification

	ASC	ASI
Voltage	230 V, 50 Hz ~, 1 Ph	230 V, 50 Hz ~, 1 Ph
Current	30 A resistive, 10 A inductive	30 A resistive

Connecting the CBI ASC / ASI to Wi-Fi

Step 1 - Download the App

Option 1: Search for **CBI Home** on the App Store or on Google Play and install. See App icon below:



Option 2: Scan the QR code below and select App Store or Google Play:



Available on the App Store or on Google Play:



Apple and the Apple logo are trademarks of Apple Inc., registered in the U.S. and other countries and regions. App Store is a service mark of Apple Inc. Google Play and the Google Play logo are trademarks of Google LLC.

CBI Astute
Instruction Manual

Page 5

3990A963 REV A

Step 2 - Register a new account

Once installed, open the CBI Home App, tap “**Allow**” on the pop-up message if you would like to receive notifications.

The following screen will appear, tap on **register**:

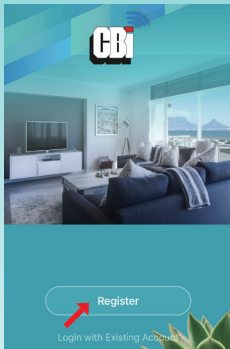
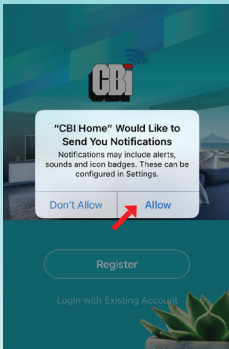

A privacy policy pop-up message will appear, read and tap “**Agree**” to proceed:

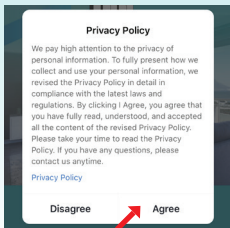

Register with an email address or mobile number. Once the chosen email address or mobile number has been entered, tap on “**Get Verification Code**”. A six digit verification code will be sent to the email address or mobile number provided.

< Email Mobile Number

Register by Email

South Africa >

Email

Get Verification Code

I Agree [User Agreement](#) and [Privacy Policy](#)

< Email Mobile Number

Register by Mobile Number

South Africa +27 >

Mobile Number

Get Verification Code

I Agree [User Agreement](#) and [Privacy Policy](#)

Enter the 6 digit verification code to register a user profile.

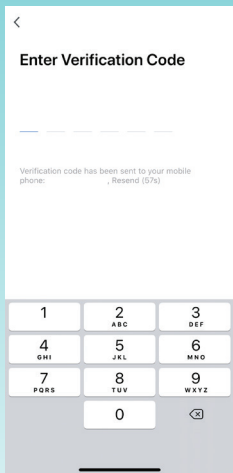
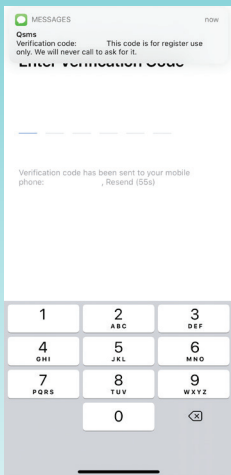

Once the verification code has been entered, create a personalised password and tap “done”.

The password must contain 6 to 20 letters and numbers. Allow the App to use your location (tap allow).

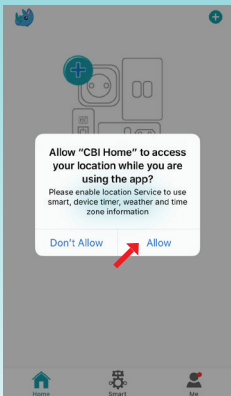
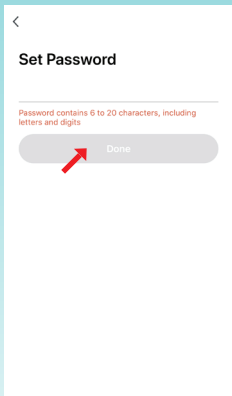

Step 3 - Pair device to App

Tap “**add device**” to add the device to your App (smartphone / tablet should be connected to the same 2.4 GHz Wi-Fi connection). For adding additional devices tap “+” in the right-hand corner.

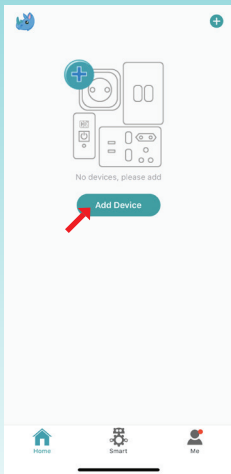

Step 4 - Select ASC (Wi-Fi) or ASI (Wi-Fi)

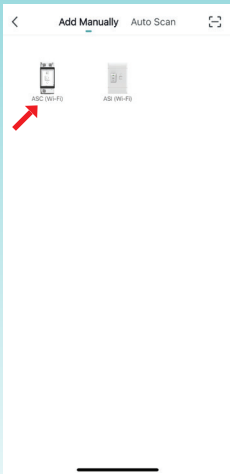

Step 5 - Initiate pairing mode

Push and hold the Power Button on the CBI Astute Smart device for 5 seconds and release. Observe the LED indicator light flashing **blue rapidly**. If yes, pairing mode is active, tap **“confirm indicator rapidly blink”** on screen.

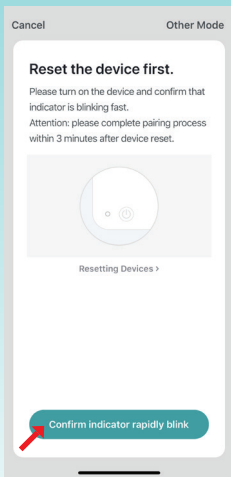

Step 6 - Enter the Wi-Fi password and confirm

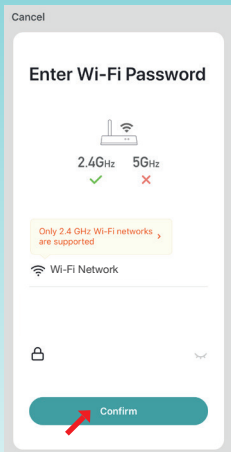

Step 7 - Download status will be displayed on the screen

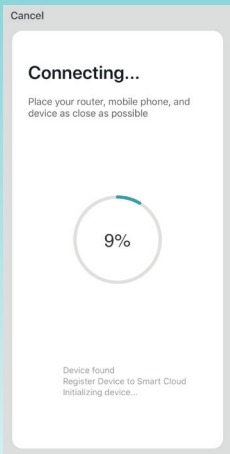

If connection attempt fails:

1. Repeat step 5.
2. If the problem persists, repeat step 3 to 7 or contact CBI on the support email: astute@cbi-electric.com.

Note: If the indicator light stops flashing while in pairing mode the device has been found and is busy connecting.

Step 8 - Rename the device

Tap on the edit button and change the device name if required.
Press save.

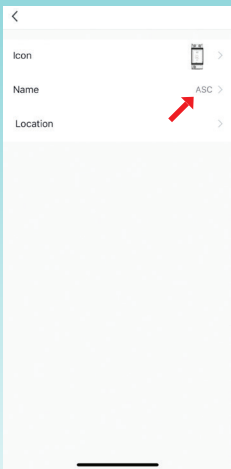
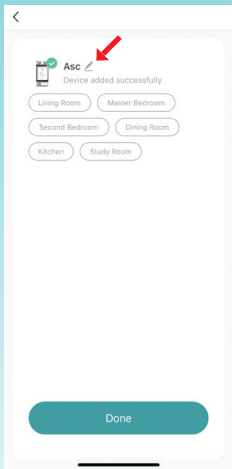

Step 9 - Setup complete

The device can now be controlled via the App.

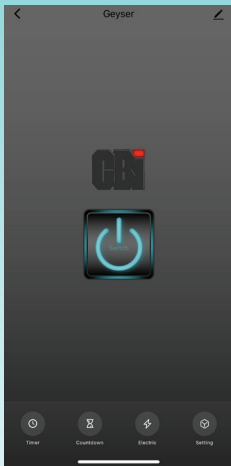

How to delete schedules

Tap and hold to delete; or swipe to the left to delete (dependant on mobile platform)

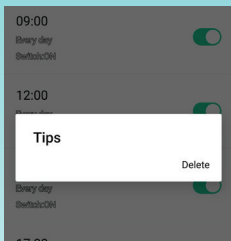

or

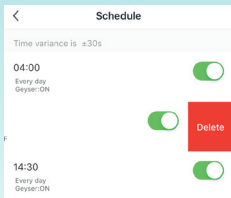

Programming instructions available online: www.cbi-lowvoltage.com/ASC / www.cbi-lowvoltage.com/ASI; or scan one of the QR codes:



ASC:



ASI:

CBI Astute
Instruction Manual

Page 14

3990A963 REV A

Alternatively subscribe to CBI's YouTube channel for instruction videos: [CBI-electric: low voltage](https://www.youtube.com/channel/UC...).

ASC / ASI Device Operation

Reboot Button (ASC) - Refer to page 3

Isolation Switch (ASI) - Refer to page 4

Power Button

Power Button		
	Press Power Button and release after	LED Status
Manual Control	1 second	RED FLASH
Wi-Fi Pairing	5 seconds	BLUE FLASH

LED Status Information

LED Status Indication						
Power	Wi-Fi	Pair Mode	Output	LED Status		Comment
				RED	BLUE	
OFF	*	*	*	OFF	OFF	Power OFF
ON	*	UNPAIRED	OFF	ON	OFF	Not paired and / or no Wi-Fi
ON	*	ACTIVE	OFF	OFF	ON FLASHING	Pairing Mode active
ON	ON	PAIRED	OFF	OFF	ON	Successful connection to Wi-Fi and output OFF
ON	*	PAIRED	ON	ON FLASHING	ON	Manual or App output ON
ON	*	UNPAIRED	ON	ON FLASHING	OFF	Manual ON only
ON	*	UNPAIRED	ON	ON FLASHING	ON FLASHING	Not paired and / or no Wi-Fi and output ON

Power Failure

The unit will not operate during a power failure. The functions of the ASC / ASI will be re-established when power and a Wi-Fi and internet connection is restored.

Troubleshooting

1. Cannot download the App

A: Go back to step 1 and download the App by scanning the QR code.

2. Cannot discover the device on the App

A: Ensure that the Wi-Fi router is 2.4 GHz and connected to the internet; and that the smartphone and ASC / ASI device connects to the same Wi-Fi.



Head Office:

1 Tripswitch Drive
Elandsfontein
Gauteng
South Africa
1401

Private Bag 2016
Isando
1600

A member of the **REUNERT** Group

Tel: +27 11 928 2000
Fax: +27 11 392 2354
Hotline: 0860 BREAKR
Email: cbi@cbi-electric.com
Website: www.cbi-lowvoltage.com

Version 1 - 2020

© 2020 CBI (Pty) Ltd. All Rights Reserved.



Website



LinkedIn



Facebook



YouTube

Please review our Customer T & Cs on www.cbi-lowvoltage.co.za

All rights reserved. Unless otherwise indicated, all materials on these pages are copyrighted by CBI (Pty) Ltd. No part of these pages, either text or image may be used for any purpose other than personal use. Therefore, reproduction, modification, storage in a retrieval system or retransmission, in any form or by any means, electronic, mechanical or otherwise, for reasons other than personal use, is strictly prohibited without prior written permission. CBI (Pty) Ltd reserves the right to alter any details of this document without notice and while every effort is made to ensure the accuracy of the content, no warranty is given as to accuracy of this document and no responsibility will be accepted for error or misinterpretation and any resulting loss.