



# Allbrox® SMC Enclosures

The most advanced Industrial enclosure range in the world.



## “SMC is Green”

Energy use is an important element in the total environmental impact of a product. Producing materials from base materials requires energy in each step of the process. A way to compare the energy use for the production of a part is to calculate back to equal properties. In the graph below the relative use for producing a part with equal tensile strength and equal tensile stiffness is represented:

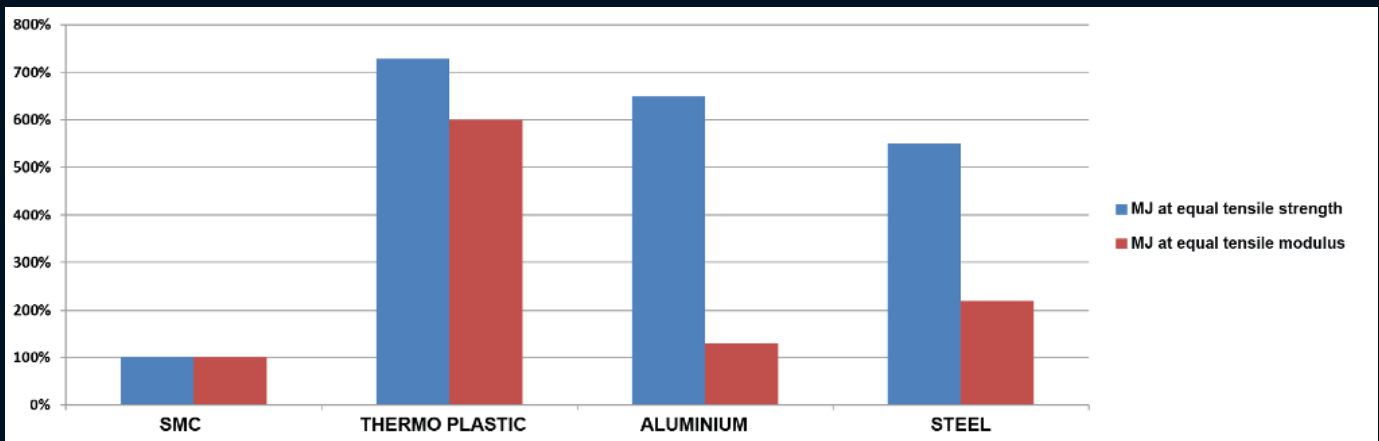

***“ a part produced in SMC requires 5-7 times less energy to be produced than producing the same part in steel, aluminium or thermoplastic materials at equal strength”***



# Chemical resistance of SMC

## RATING KEY:

<b>E</b>	Excellent	<b>P</b>	Poor
<b>G</b>	Good	<b>NR</b>	Not Recommended

Chemical	Rating	Chemical	Rating	Chemical	Rating
Acetic Acid (10%)	E	Fluorine	NR	Perchloroethylene	E
Acetone	P	<b>Formaldehyde</b>	E	Petrol	G
Acetaldehyde	NR	<b>Formic Acid</b>	E	Phosphoric Acid (25%)	P
Aluminium Chloride (10%)	E	Glycerine	E	Phosphoric Acid (50%)	NR
Aluminium Sulfate (10%)	E	Hydraulic Brake Fluid	E	Potassium Carbonate	E
Ammonia Gas	E	Hydraulic Oil	E	Potassium Chloride (25%)	E
Ammonium Chloride	E	Hydrochloric Acid (10%)	G	Potassium Hydroxide (25%)	NR
Ammonium Hydroxide (10%)	P	Hydrocyanic Acid	NR	Potassium Nitrate (10%)	E
Ammonium Nitrate (10%)	E	Hydrofluoric Acid (20%)	NR	Potassium Sulfate (10%)	E
Ammonium Phosphate(10%)	G	Hydrogen Peroxide	G	Sodium Bicarbonate (10%)	E
Ammonium Sulfate	E	Hydrogen Sulfide	E	Sodium Bisulfate (10%)	P
Aniline	NR	Hypochlorous Acid	E	Sodium Chloride (25%)	E
Axle Grease	E	Isopropyl Alcohol	E	Sodium Hydroxide	NR
Benzene	E	Kerosene	E	Sodium Hypochlorite (15%)	G
Boric Acid (10%)	E	Lacquer Thinner	E	Sodium Nitrate (10%)	E
Bromine	P	Lactic Acid	E	Sodium Phosphate (10%)	E
Butyl Acetate	P	Lime	G	Sulfuric Acid (25%)	E
Butyric Acid	E	Liquid Dish Soap (10%)	E	Sulfurous Acid (10%)	NR
Calcium Chloride (10%)	E	Lubricating Oils	E	Tannic Acid (10%)	E
Calcium Hydroxide (10%)	E	Magnesium Chloride (10%)	E	Tetrahydrofuran	P
Calcium Hypochlorite (10%)	G	Magnesium Hydroxide (10%)	E	Toluene	E
Calcium Sulfate	E	Mercuric Chloride	G	Trichloroethylene	NR
Carbolic Acid (25%)	P	Isopropyl Alcohol	E	Trisodium Phosphate	G
Carbon Disulfide	P	Kerosene	E	Turpentine	G
Carbon Tetrachloride	G	Lacquer Thinner	E	Vegetable Oils	E
Chlorine (dry)	E	Lactic Acid	E	Vinegar	E
Chlorine (water) 5-10 ppm	P	Lime	G	Water, Industrial	E
Chlorobenzene	E	Liquid Dish Soap (10%)	E	Water, Sea	E
Chloroform	NR	Lubricating Oils	E	Water, Tap	E
Chrome Plating Solutions	P	Magnesium Chloride (10%)	E	Xylene	E
Chromic Acid (10%)	E	Magnesium Hydroxide (10%)	E	Zinc Acetate	E
Citric Acid (10%)	G	Mercuric Chloride	G	Zinc Chloride	E
Copper Sulfate (30%)	E	Methyl Ethyl Ketone	P	Zinc Sulfate	E
Creosote	P	Methylene Chloride	E		
Diethyl Ether	E	Milk	E		
Ethyl Alcohol	E	Mineral Oil	E		
Ethylene Dichloride	P	Mineral Spirits	E		
Ethylene Glycol	E	Nickel Salts	E		
Ferric Chloride	E	Nitric Acid (10%)	G		
Ferric Nitrate	E	Nitrobenzene	P		
Ferric Sulfate	E	Oleic Acid	E		

\*Note: This table is for reference purposes only

# Comparison Table between SMC, Plastic & Metal enclosures



	SMC	Plastic	Mild Steel Powder Coated
Corrosiveness	Non-Corrosive	Non-Corrosive	Corrosive
Conductivity	Non-Conductive	Non-Conductive	Conductive
Flammability	Non-Flammable	Flammable (unless stabilizer is added). Where flame retardant additives are added material will continue burning if source of flame is sustained e.g. Arcing	Non-flammable
UV Resistance	25+ years UV resistant	Not UV resistant, UV additives can extend life of plastic from months to years but mechanical material properties are compromised over extended periods in excess of 7 years.	UV resistant
Structural integrity	Maintains structural integrity in temperatures from -50 to 200 degrees.	Does not hold structural integrity under temperatures above 80 to 110 degrees depending on grade.	Maintains structural integrity
Manufacturing Variances	Can be consistently moulded to exact dimensions (Maintaining consistent IP rating)	Tolerance during moulding can vary up to 2cm for Polyethylene. Other engineering plastics like polycarbonate have high predictability and good tolerance.	Tolerances can vary according to manufacturer.
Heat Resistance	Internal temperatures remain cool in direct sunlight. Material is cool to touch	Internal temperature remains cool in direct sunlight. Material is cool to touch	Transfers radiant heat.

## Main benefits of SMC:

### HIGHLY CORROSION RESISTANT

- Even in highly aggressive areas and chemical exposures Allbro's SMC Products offer excellent corrosive resistance.
- Corrosion is a multimillion Rand problem and represents an estimated cost of 4% of a country's GDP.
- Allbro's SMC eradicates this costly corrosion challenge.

### NON-CONDUCTIVE

- SMC products are ideal for use in areas where conductivity is a concern. Due to their non-conductive nature our products are safe to human contact and as such do not have to be earthed.

### HIGH STRENGTH

- SMC Products offer exceptional strength-to-weight ratios.
- Our exceptional light weight products possess similar strength properties to steel.

### RF / GSM TRANSPARENCY

- Metal enclosures block RF signals. (Users tend to install external antenna connectors but these are vulnerable to environmental corrosion, natural ambient interference and vandalism).
- SMC is transparent to radio waves, microwaves, and other electromagnetic frequencies.
- Allbro's SMC products are regularly used in telecoms applications due to this key feature.

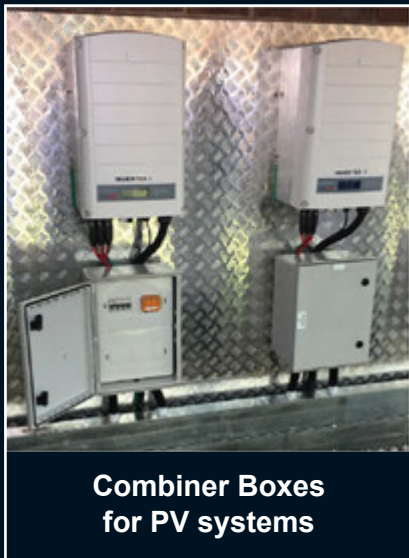
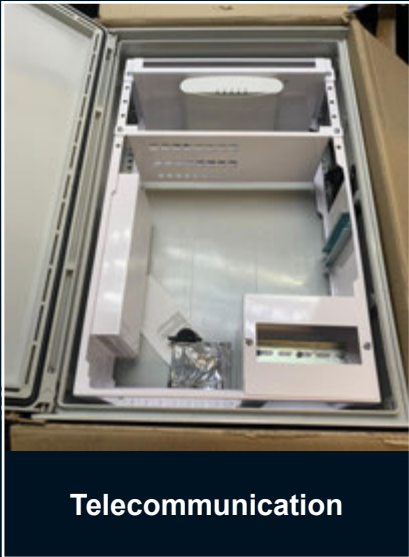

# Allbrox® 3 - 6D Features

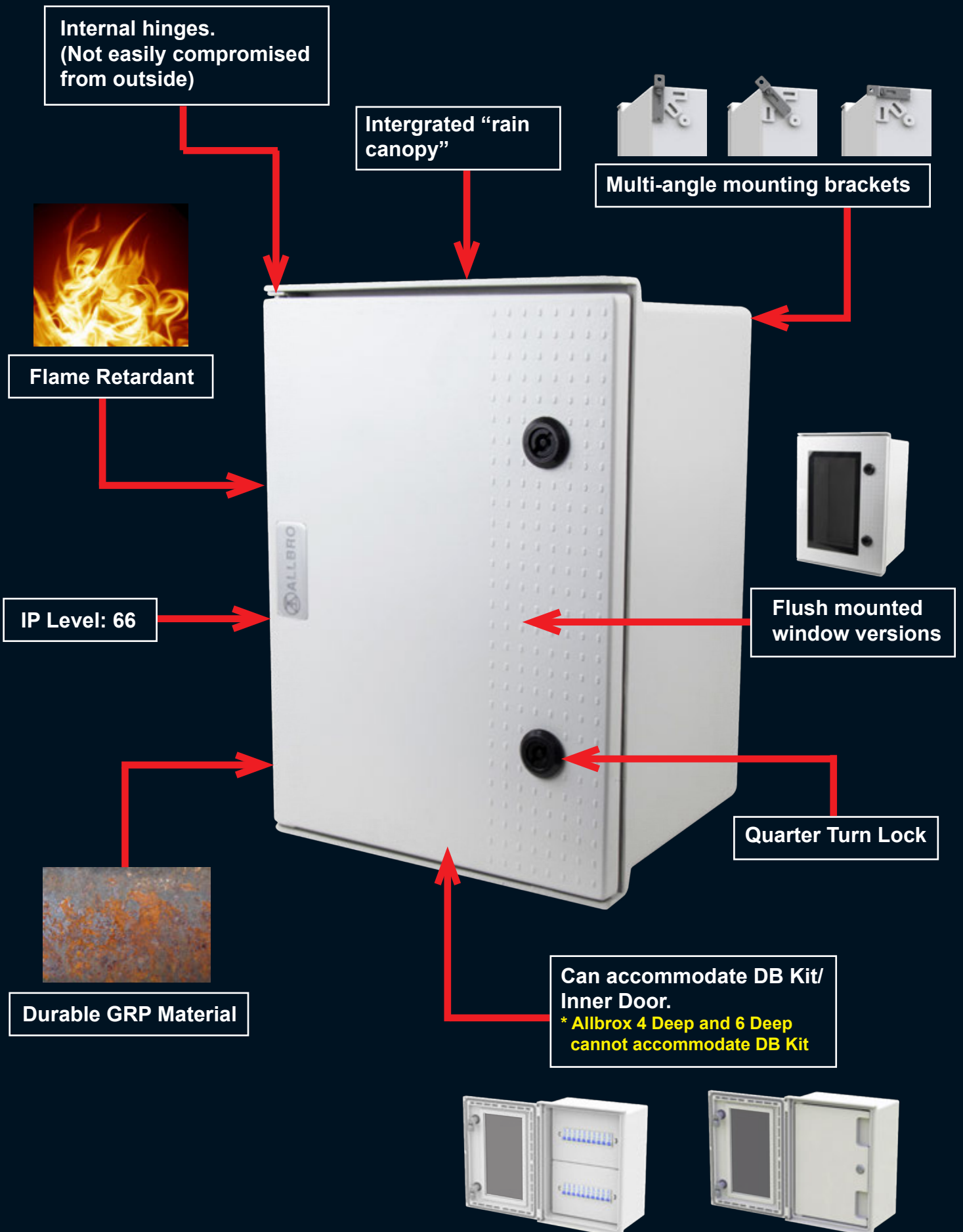

Material	SMC (Sheet Moulding Compound)			
Operating Temperature	-50° C to + 200° C			
Glow Wire Capability / Flammability	960° / UL94 V0			
Expected UV Life (Direct Exposure)	25 years +			
IP Level	IP66			
IK Level	IK10			
Security Level	1	2	3	4

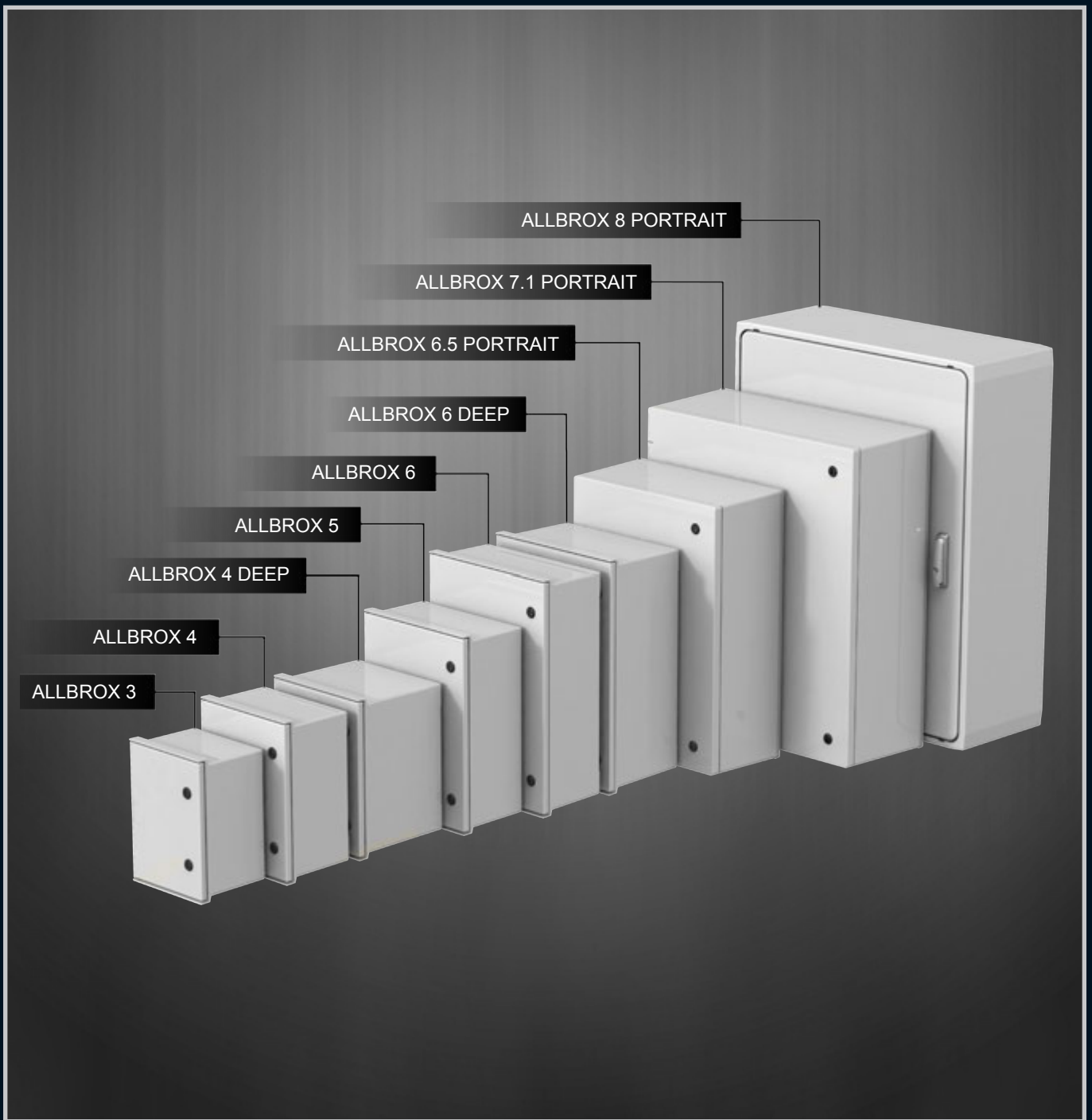

<b>Material</b>	SMC (Sheet Moulding Compound), PC for window			
<b>Operating Temperature</b>	-50° C to + 200° C			
<b>Glow Wire Capability / Flammability</b>	960° / UL94 V0			
<b>Expected UV Life (Direct Exposure)</b>	25 years +			
<b>IP Level</b>	IP66			
<b>IK Level</b>	IK10			
<b>Security Level</b>	1	2	3	4





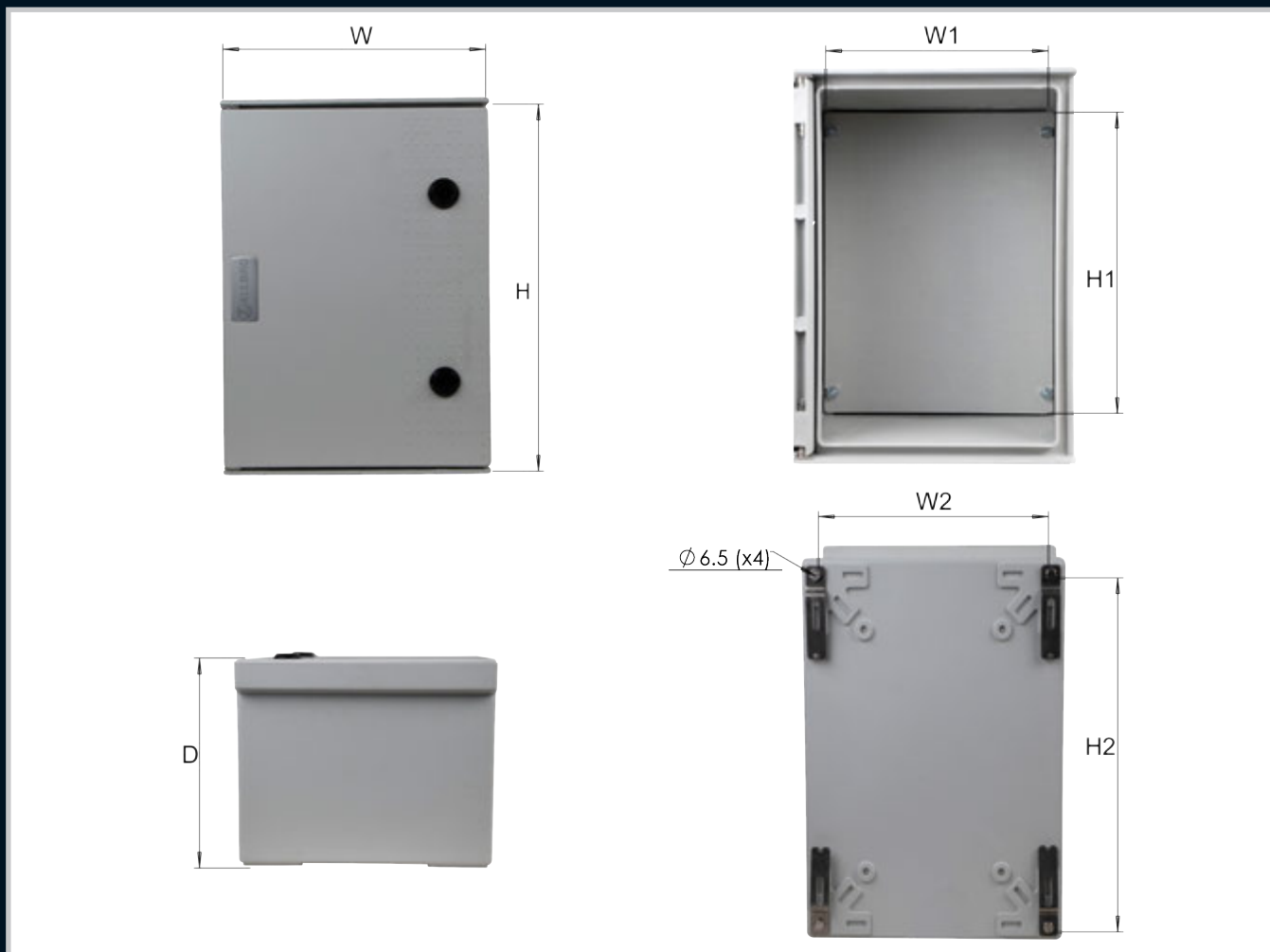

Part Number (Grey)	Part Number (Orange)	Description	H (mm)	W (mm)	D (mm)	W1 (mm)	H1 (mm)
ALL-003	ALL-003/O	Allbrox 3 with SMC Device plate	350	250	200	212	317
ALL-004	ALL-004/O	Allbrox 4 with SMC Device plate	400	300	200	262	364
ALL-004/D	ALL-004/D/O	Allbrox 4 Deep with SMC Device Plate	400	300	273	262	364
ALL-005	ALL-005/O	Allbrox 5 with SMC Device plate	500	350	200	312	467
ALL-006	ALL-006/O	Allbrox 6 with SMC Device plate	600	400	200	362	567
ALL-006/D	ALL-006/D/O	Allbrox 6 Deep with SMC Device Plate	600	400	250	362	567
ALL-006_5-L	ALL-006_5-L/O	Allbrox 6.5 Landscape with SMC Device Plate	500	700	246	619	419
ALL-006_5-P	ALL-006_5-P/O	Allbrox 6.5 Portrait with SMC Device Plate	700	500	246	419	619
ALL-006_5-L/D	ALL-006_5-L/D/O	Allbrox 6.5 Deep Landscape with SMC Device Plate	500	700	366	619	419
ALL-006_5-P/D	ALL-006_5-P/D/O	Allbrox 6.5 Deep Portrait with SMC Device Plate	700	500	366	419	619
ALL-007_1-P	ALL-007_1-P/O	Allbrox 7.1 Portrait with SMC Device plate	828	710	287	634	754
ALL-007_1-L	ALL-007_1-L/O	Allbrox 7.1 Landscape with SMC Device plate	710	828	287	754	634
ALL-008-P	ALL-008-P/O	Allbrox 8 Portrait with SMC Device plate	1000	800	320	710	910
ALL-008-L	ALL-008-L/O	Allbrox 8 Landscape SMC Device plate	800	1000	320	910	710

### Allbrox Galvanised Steel Device Plate

Part Number	Description	H (mm)	W (mm)	Thickness
ALL-M/SMPLATE-3	ALL Mounting Steel Plate No.3	311	238	1.6
ALL-M/SMPLATE-4	ALL Mounting Steel Plate No.4	361	288	1.6
ALL-M/SMPLATE-5	ALL Mounting Steel Plate No.5	461	338	1.6
ALL-M/SMPLATE-6	ALL Mounting Steel Plate No.6	554	380	1.6
ALL-M/SMPLATE-6_5	ALL Mounting Steel Plate No.6_5	590,7	390,7	2
ALL-M/SMPLATE-7	ALL Mounting Steel Plate No.7	605	532,7	2

## ALLBROX® 4-6

### Distribution Board Kit



### Allbrox® Distribution Board Kit

Part Number	Description	No. of Rows	MCB's Per Row	No. of Neutral Bars	No. of Earth Bars
ALL-004/DBK-A	Allbrox 4 Distribution Board Kit Assembled	2	10	2x (14 way)	2x (12 way)
ALL-005/DBK-A	Allbrox 5 Distribution Board Kit Assembled	3	13	4x (14 way)	4x (12 way)
ALL-006/DBK-A	Allbrox 6 Distribution Board Kit Assembled	4	15	5x (15 way)	2x (18 way) + 2x (12 way)

### Allbrox® Distribution Board Kit Assembly

1) Remove device plate from the base. Leave the 4 x M6 nuts in place for fixing the mounting rails in place. Fit mounting rails (A) as shown using the 4 x M6 x 12 CH EG screws and M6 washers. Ensure that the bigger space between the hole and end of the mounting rail is fitted toward the hinge side of the box

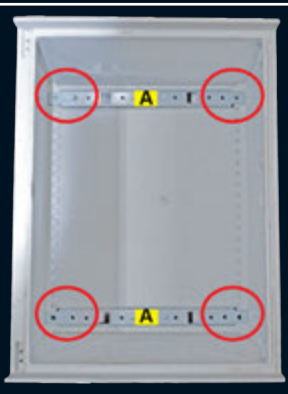

2) Fit the steel side plates with the plastic supports (B) onto the mounting rails (A) using the 4 x M6 x 12CH EG screws and M6 washers as shown.



3) Fit the steel din rails (C), for breakers, into the plastic supports using 2 x 3.5 x 12 Panpozi thread cutter screws on each end as shown. Fit the steel din rail, for neutral bar, upside down using 2 x 8 x 9.5 thread cutter screws on each end as shown.

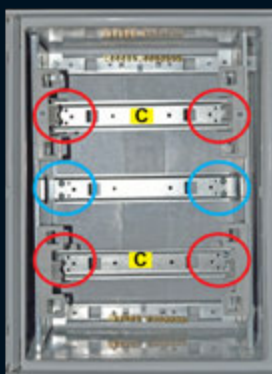

3.5 x 12 Panpozi thread cutter screws  
8 x 9.5 Panpozi thread cutter screws

4) Clip the plastic Fascia plates (D) into the plastic supports as shown.

Product	No. Fascia Plates
ALLBROX 4	2
ALLBROX 5	3
ALLBROX 6	4



## ALLBROX® 4-6

### Inner Doors



#### Allbrox® Inner Door

Part Number	Description
ALL-004/IN/DOOR	Allbrox 4 Inner Door
ALL-005/IN/DOOR	Allbrox 5 Inner Door
ALL-006/IN/DOOR	Allbrox 6 Inner Door

#### Allbrox® with PC Window

Part Number	Description
ALL-003/CLEARPC	Allbrox 3 with clear Polycarbonate window
ALL-004/CLEARPC	Allbrox 4 with clear Polycarbonate window
ALL-005/CLEARPC	Allbrox 5 with clear Polycarbonate window
ALL-006/CLEARPC	Allbrox 6 with clear Polycarbonate window

### Allbrox® Inner Door Fitting Options

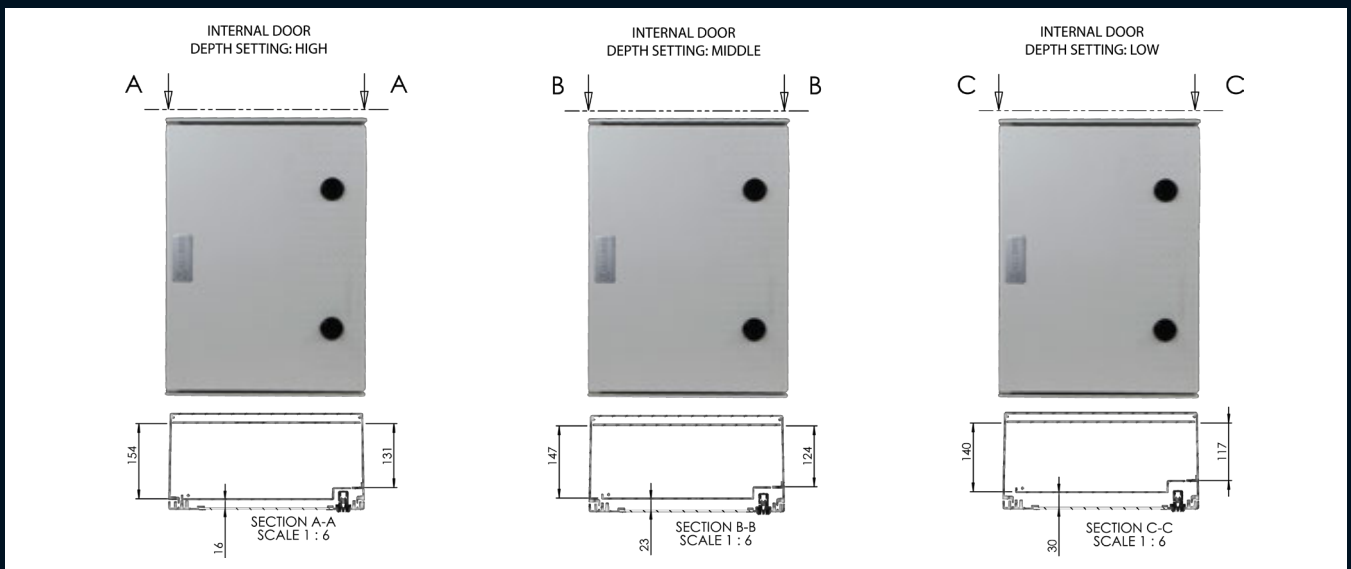

1) To remove or place the inner door in an Allbrox® simply pull the two hinge pins as indicated towards each other.



2.1) To remove the door, complete step 1 and pull the inner door towards yourself.

2.2) To place the inner door into the Allbrox® complete step 1 and let the hinge pins go once the pins are inline with the hinge sleeve.

\* Please note that the construction of the 6.5 and 7.1 sizes differs from the smaller sizes (3-6D). The features therefore differ.

## ALLBROX® 6.5

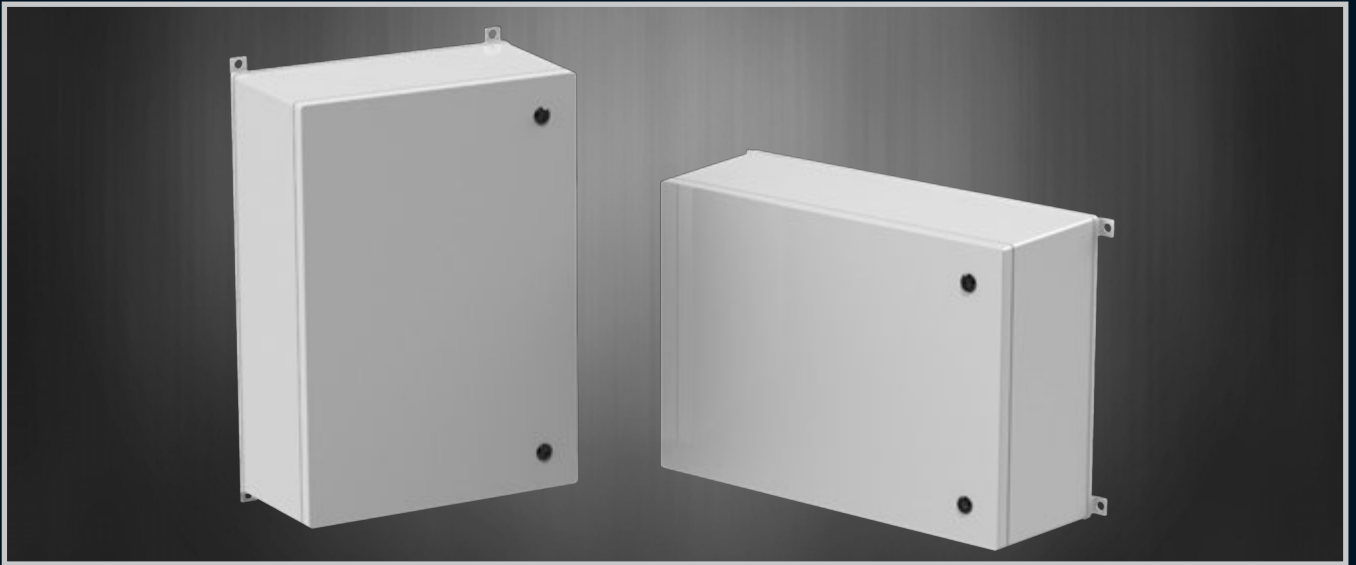

## ALLBROX® 7.1

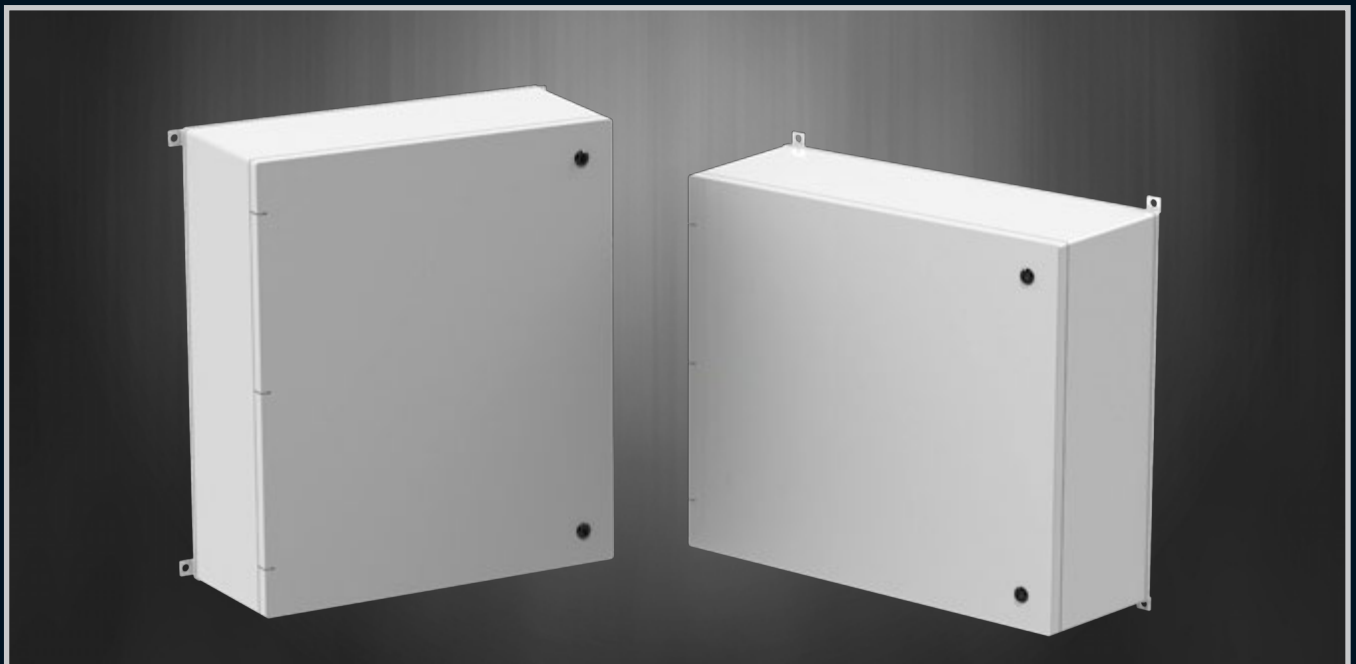

Door locator



Extra strength lid



Easily Removable door

## CONTACT US

121, Corner 13th Avenue and Dormehl Street  
Anderbolt Ext 32  
Boksburg  
1459

Tel: +27 11 894 8341  
Fax: +27 11 918 1072  
Email: [sales@allbro.com](mailto:sales@allbro.com)  
[www.allbro.com](http://www.allbro.com)



Copyright© 2020 Allbro  
All rights reserved